

Olsbergs

means total control

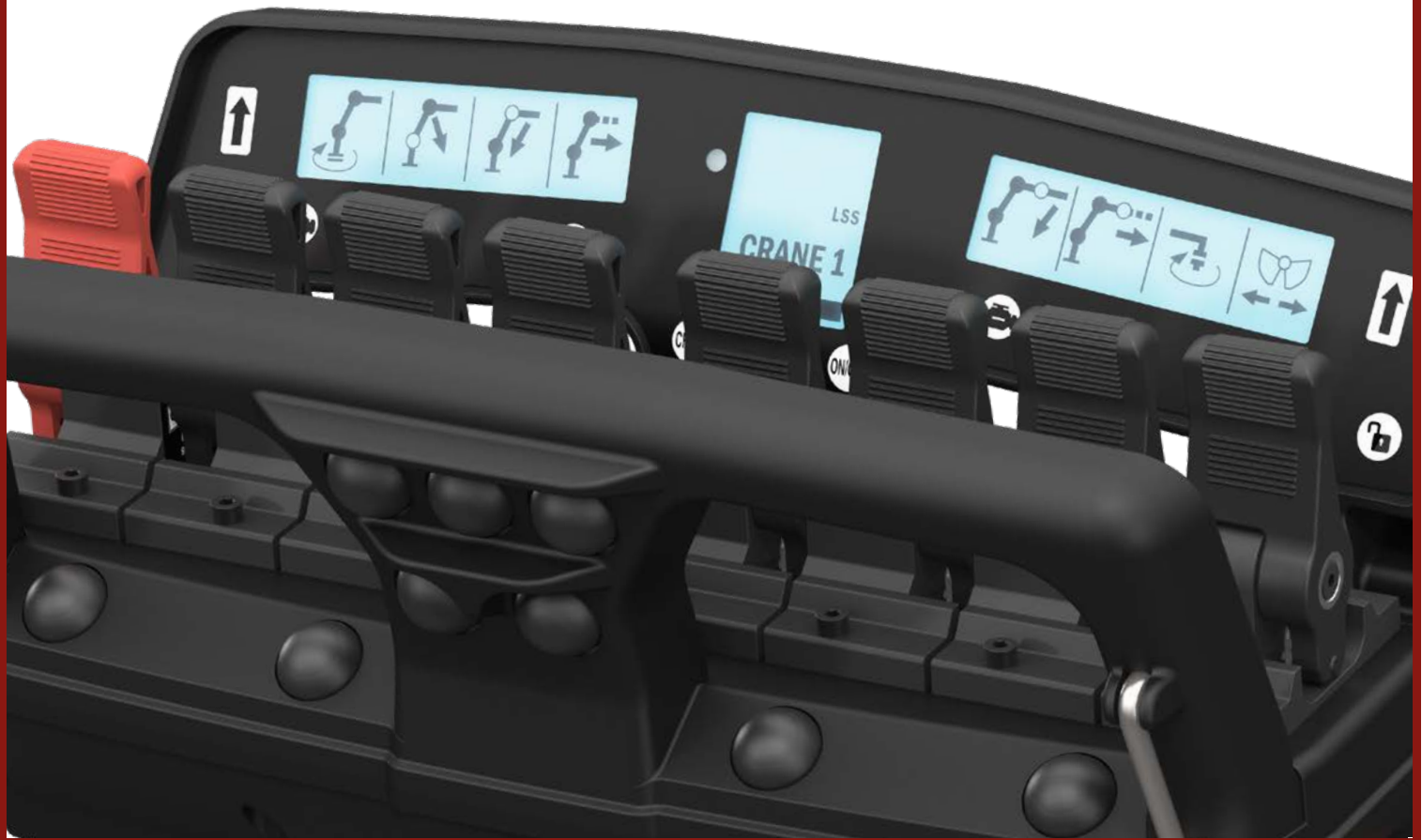

MultiDrive 3

Controller Display 8F

2017

 English

Table of content

Chapters

Introduction	Page 3
Radio decoder	Page 4
Controller	Page 5
Getting started	Page 6 - 7
Menu system	Page 8
Main menu "CRANE"	Page 9
Main menu "EXTRA"	Page 10
Main menu "ON-OFF"	Page 11
Centre display, view modes	Page 12 - 13
Overload protection "OLP"	Page 14 - 15
Other instructions	Page 16 - 17
Spare parts	Page 18 - 19

Titles

Activating the controller	Page 6
Activating the system on the crane	Page 6
Blocking on max load/release	Page 15
Cable control	Page 17
Crane-OLP	Page 14
Engage manual extension	Page 18
Error code display	Page 13
Fault indication	Page 13
Installing the battery	Page 6
Locking/unlocking the hand controller	Page 16
Low ambient temperature	Page 16
Outrigger-OLP	Page 14
Radio / decoder blink modes in different operating cases	Page 4
Replacing a hand controller or decoder	Page 16
VSL-OLP	Page 14

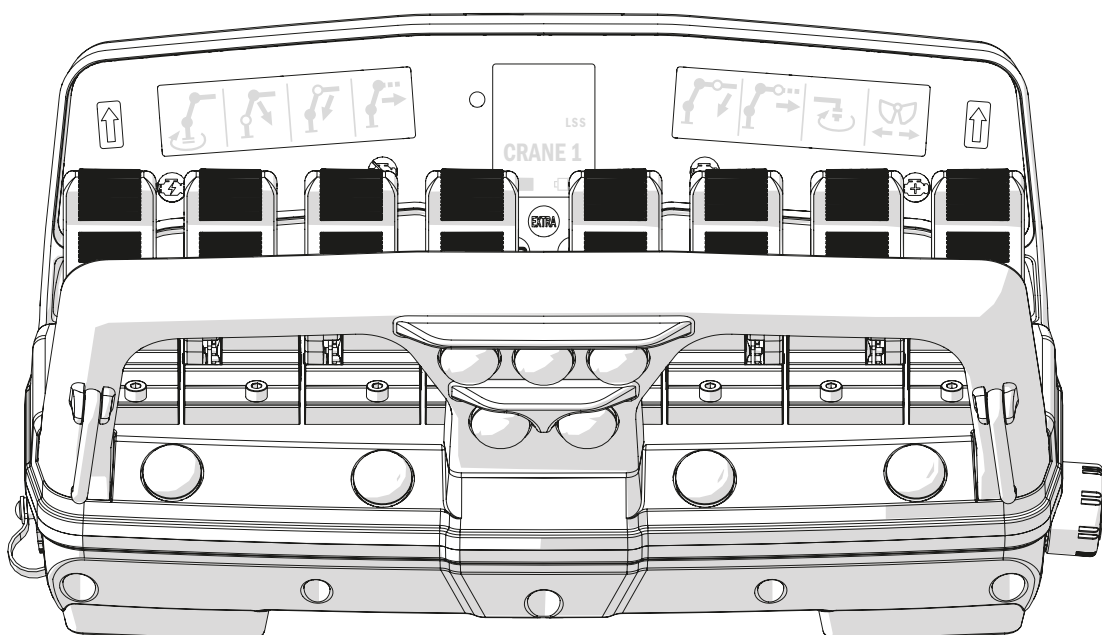

Introduction

Safety philosophy

The control system fulfils stringent safety requirements in terms of reliability and operational safety.

The products are CE-marked and approved in accordance with machinery directive 2006/42/EG.

The radio conforms with the R&TTE Directive (2014/53/EU, RED) and Harmonized European Standard ETSI EN 300 220-2 V3.1.1



Olsbergs radio remote control system has been developed to provide operators with continual feedback via its displays on the hand controller. The hand controller's standard menu selection system utilises the displays to provide the operator with real time information about the chosen menu, battery status, reception conditions etc.

The hand controller contains a two-way communication radio enabling information to be sent both to it and from it. The radio decoder contains a corresponding unit to handle traffic at the other end.

The hand controller utilises 868 Mhz radio with max. e.r.p of 25 mW, which is operating in the ISM 863–870 Mhz frequency band, a free band approved by the European Commission.

- This means that no license is needed and the radio can in principle be used everywhere in EU including over national boundaries. For detailed information about free band use see www.efis.dk

The side displays show the symbol for the function each lever activates in the chosen menu. When the operator changes menu, the symbols change to the functions that become active.

The centre display provides information about which menu has been chosen, as well as indicating the radio reception conditions, battery status, fault information, micro, manual extension and so on. Furthermore information about VSL+ and stability diagram is displayed in the centre display.

Radio Decoder

The radio decoder contains one of the radio units. The decoder translates the radio traffic, consisting of lever and button data from the hand controller, to the CAN bus.

For safety reasons, it is extremely important that data is not corrupted, therefore the decoder has dual micro-processors which monitor each other to ensure accuracy in the translation. The controller and the decoder must be “paired” with each other to establish a connection. A unique code is loaded and stored in each unit. The pairing procedure is described elsewhere in this documentation.



- LED L1: Fault status
- LED L2: Radio communication status
- LED L3: Radio control on
- Connector controller cable

Blink mode for each LED in different operating cases:

Decoder on, under initialisation:



Cable operation:



Decoder powered, no radio connection:



Radio connection present, safety requirements not met:

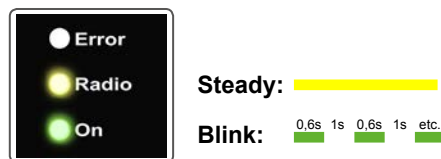

Normal operation:



Pairing procedure in progress:



Pairing procedure complete:



Internal error or failed pairing procedure:



Controller

The hand controller is the device that the operator uses to control his crane and his vehicle.

The hand controller has eight levers. The functions of each lever may be the same or different in different menus, however only one function can exist per lever at any one time. If a lever is faulty, or if it is deflected on starting, it is disabled. The other levers operate as usual.

Activating the micro-button enables the operator to set the levers to two preset values e.g. 50% or 20% of normal speed thus enabling the crane to be operated with increased precision.



Battery
1700 mAh

Buttons for main menu

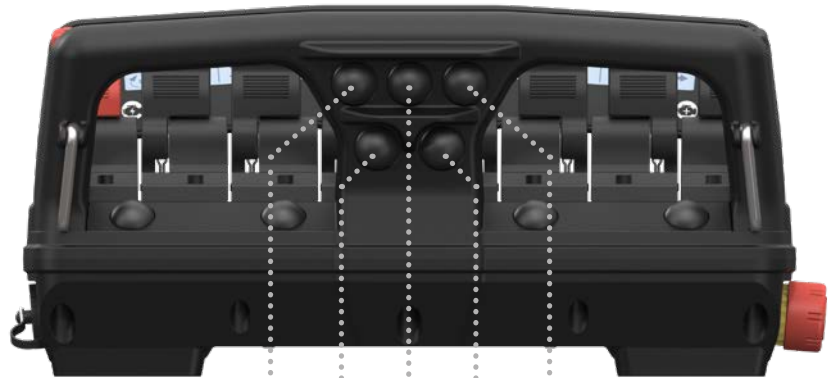

Crane **Extra** **On-Off**
Horn **Micro**

"Twilight relay"

Side display, left

Centre display

Side display, right

Info button
showing error codes in the centre display

Lever 1-8
display symbol shows direction of operation with lever forward

Release button

Stop button

Cable connector

Configurable buttons
for on/off functions e.g. start/stop engine, rpm up/down etc.



Getting started

Installing the battery

Install a fully-charged battery in the hand controller as shown on the right. **(1)**

The battery must be installed correctly **(2)** or the hand controller will not start.

A fully-charged 1700 mAh battery provides approximately 8 hours of operation.

Activating the system on the crane

To turn on the crane's control unit press the on button on the Space X4 RC Box. The LED above the button will then start to blink. **(3)**

Then press the remote control button on the Space X4 RC Box. The LED above this button will first start blinking and when the radio connection is established it will light steadily. **(4)**

The decoder starts when remote control operation is selected and the decoder's yellow LED starts to blink.

The crane's control and safety system is now ready to be connected with the hand controller.

Activating the controller

To activate the hand controller pull the stop button out by turning it clockwise **(2)**. The hand controller is powered up and starts to establish a radio link with the decoder on the crane. While radio contact is being established a flashing hourglass and the text "Wait" is shown on the centre display. **(6)**

Remaining battery power is displayed and the signal strength symbol flashes when radio communication is established but the hand controller and decoder are still exchanging connection data.

Connection time for a cold-start can be up to 5 seconds. A cold-start occurs when the hand controller or decoder on the crane have been off for the last 10 minutes. When restarting within 10 minutes of turning off the hand controller, the radio link is still established and the hand controller is ready for use immediately.

The factory setting for the period of time the hand controller maintains contact with the decoder after pressing the stop button is 10 minutes.



1



2



3



4

Getting started

Radio link established

When the radio connection is established the yellow LED on the decoder shines steadily and the green LED blinks rapidly. **(5)**

The hourglass symbol on the hand controller disappears and the text "Wait" **(6)** is replaced by "CRANE 1". **(7)**

The radio signal strength is now shown without blinking.

If the radio connection is disrupted for longer than 0.5 of a second, then "CRANE 1" is replaced by the "RESTART" symbol **(8)** and the signal strength symbol will either disappears or start blinking.

To restart the controller press in the stop button and pull it out again by turning it clockwise. **(2)**

If the hand controller has been turned off it will always restart in "CRANE 1". **(9)**

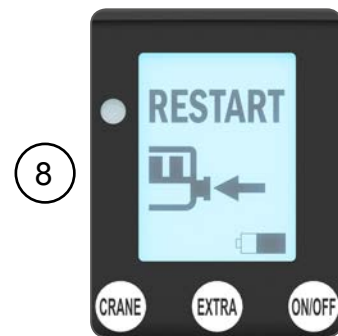
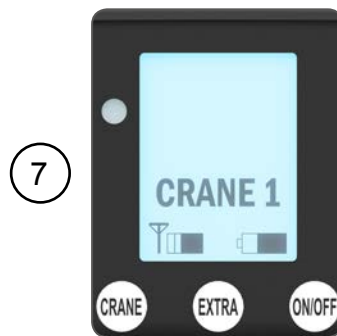
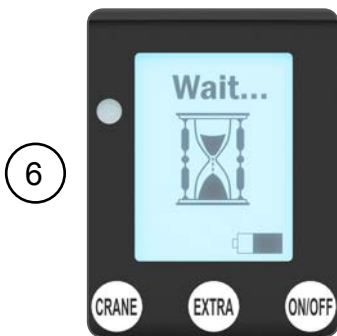

Menu system

Olsbergs hand controllers are equipped with a menu selection system as standard.

There are three main menus which can be easily accessed via three push buttons.

The main menus are:

- the CRANE menu
- the EXTRA menu
- the ON-OFF menu

In each of the main menus the operator can select sub-menus by repeatedly pressing the same button, e.g. 1-2-3 and then back to 1 again.

As standard, up to 4 menus with 8 proportional functions together with 12 on-off functions, can be programmed.

The system with main menus enables the operator to change quickly from crane operation to outrigger operation and back again.

The hand controller always restarts in menu CRANE 1.

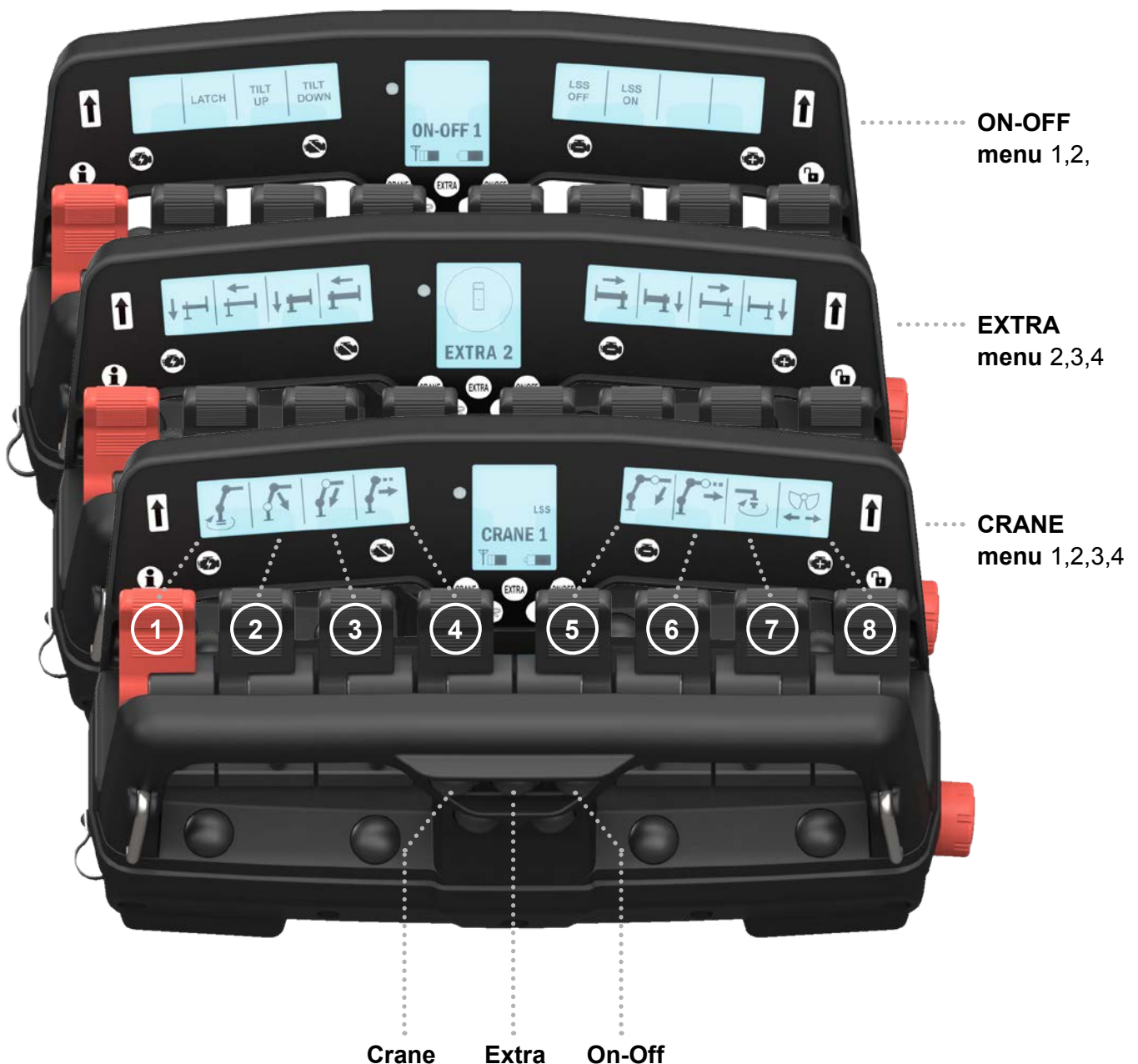

Main menu "CRANE", proportional functions

The sub-menus in "CRANE" mode are configured when the crane is fitted to the vehicle. The right and left side displays show symbols representing the functions controlled by the corresponding levers.

When the crane menu changes, the symbols and texts change to match the functions available via the current menu.

The symbols are stored in a symbol library. If the library does not contain the required symbol, a description of the function can be written instead. Only Arabic numerals and letters from the English alphabet can be used in the descriptions.

Symbols and texts can be configured via the safety system.

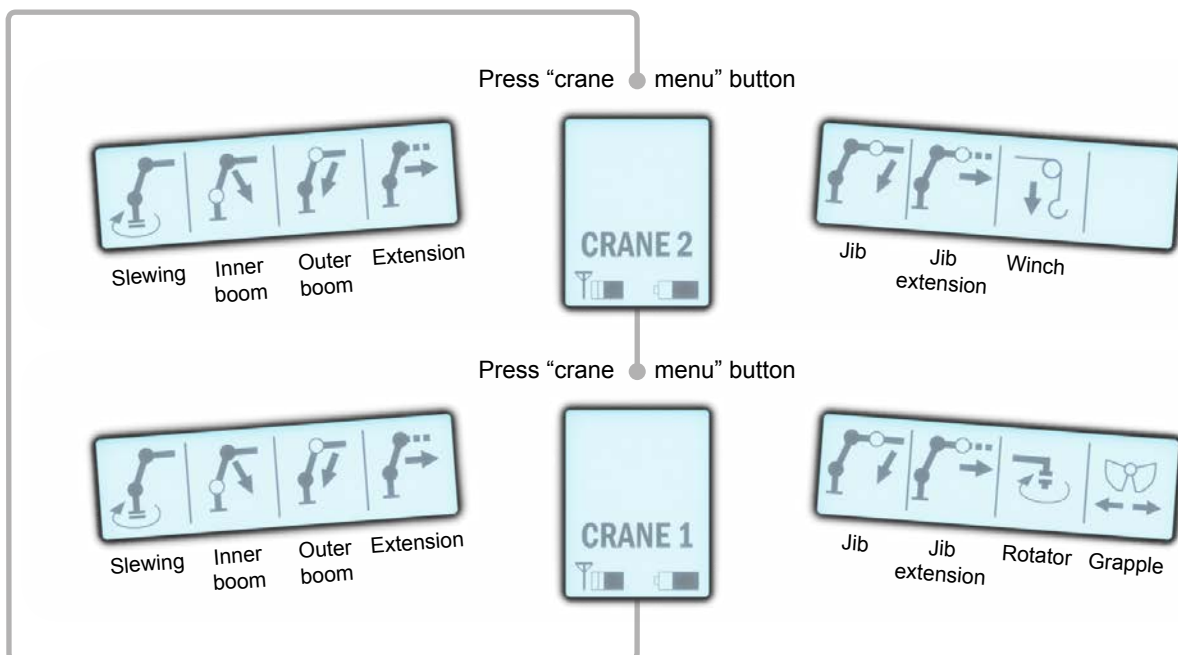

"Crane menu" button

The left-hand button in the top row on the bar, facing towards the operator. When the operator pulls out the start button on the hand controller, it always starts in menu CRANE 1.



Main menu "EXTRA", proportional functions

The "EXTRA" main menu contains additional hydraulic proportional functions that do not belong to the crane itself, such as outriggers front and rear, boat supports, levelling etc.

The symbols are stored in a symbol library. If the library does not contain the required symbol, a description of the function can be written instead. Only Arabic numerals and letters from the English alphabet can be used in the descriptions.

The symbols and descriptions are configured in the same way as the "CRANE" main menu and the same method is used for stepping between the sub-menus.

Cranes with 1 stabiliser valve



Cranes with 2 stabiliser valves

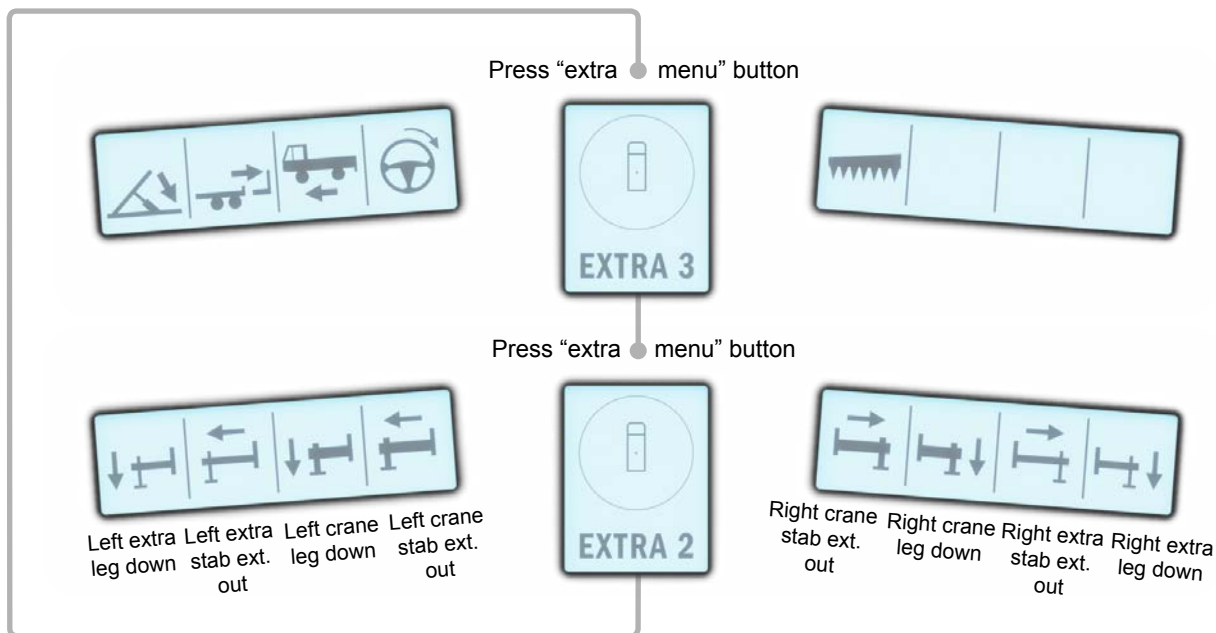

"Extra menu" button

The centre button in the top row on the bar facing the operator activates the EXTRA menu.



Main menu "ON-OFF", on-off functions

The "ON-OFF" main menu contains functions such as start, stop and throttle. The functions are configured at the bodybuilder.

No symbols are used for these functions at present, instead, a description matching the respective function and lever is shown in the display. Only Arabic numerals and letters from the English alphabet can be used in the descriptions.

The hand controller is prepared for the use of symbols for the ON-OFF functions.

The ON-OFF functions are controlled by the 4 levers located in the middle of the controller. Thus function 1 is controlled by lever 2, function 2 by lever 3 and so on. The ON-OFF functions are activated irrespective of which direction the lever is moved.

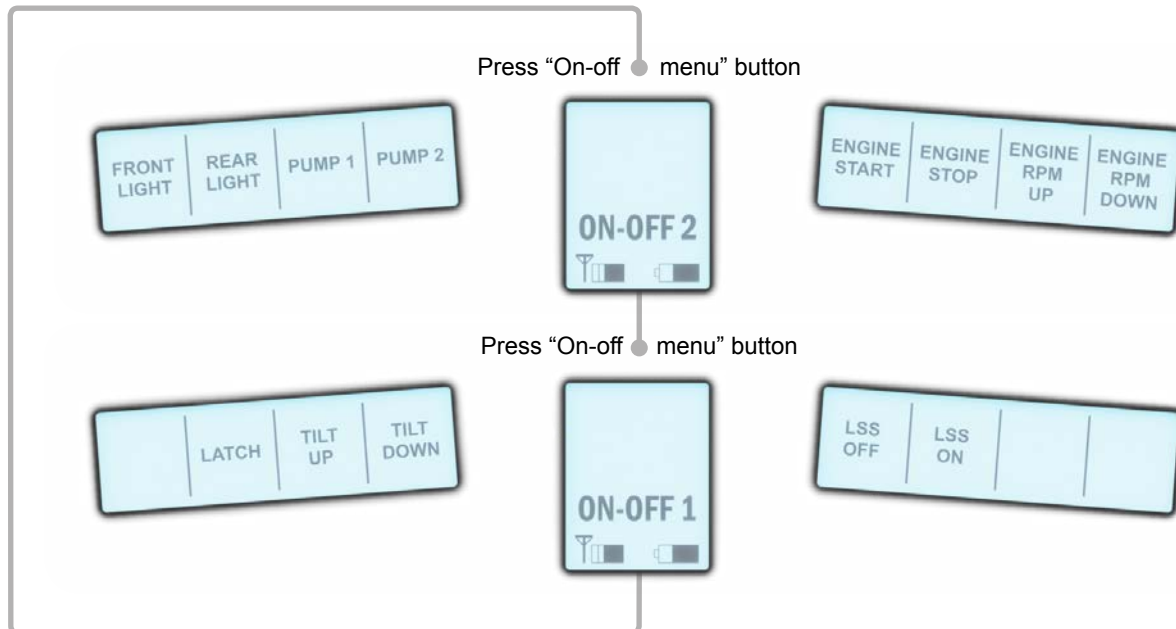

"On-off menu" button

The right-hand button in the top row on the bar facing the operator enables the ON-OFF functions.

Centre display, view modes

The centre display is the system's information centre. It shows information that is not directly related to the crane's operation.

The symbols used for this information are described in detail below.

The images to the right show the appearance of the centre display during normal radio controlled operation of the crane. LSS indicates that LSS mode has been chosen. VSL+ indicates the extra capacity that can be used thanks to load on the vehicle. The stability diagram shows eventual limitation of the lifting capacity.



Fault

A symbol of a spanner is shown when the safety system discovers a fault in the system.

Micro

Indicates that micro operation has been selected. Micro operation changes the sensitivity of the levers as follows: At full lever deflection, $\mu 50\%$ yields 50% of normal speed and $\mu 20\%$ yields 20% of normal speed for the crane. The micro values can be set at any value by Hiab.

Service

Indicates that the crane requires service.

Personnel basket or VSL+

Indicates that MEWP-mode (operation from personnel basket) has been selected. This requires greater stability and lower speeds for crane movement. VSL+ indicates how much extra lifting capacity the crane has due to load on the vehicle.

Signal strength

The number of bars shows the signal strength. Optimum reception is when all the bars are filled. When the symbol flashes the radio is connected but the start criteria have not been met.

Main menu

The text shows which main menu has been selected while the number shows which sub-menu of that main menu applies. The main menus are:

CRANE, EXTRA and ON-OFF.

NOTE! The first menu number in EXTRA is one higher than the highest in CRANE. ON-OFF is numbered from 1.

ADC (Automatic Duty Control)

Indicates that the ADC function is on.

JDC (Jib Duty Control)

Indicates that the JDC function is on.

If **HDC or LSS mode** is on it is indicated in this position on the display.

HDC (Hoist Duty Control)

LSS (Load Stability System)

Manual extension

Manual extension is selected by pressing the horn and release buttons at the same time. The safety system acknowledges by showing this symbol.

Battery capacity

The battery symbol shows the battery power remaining. When the system starts to blink there is only a few minutes of operation left. Information is sent to the safety system which can then emit a warning signal. If the system is run until the battery power fails the hand controller will automatically lock.

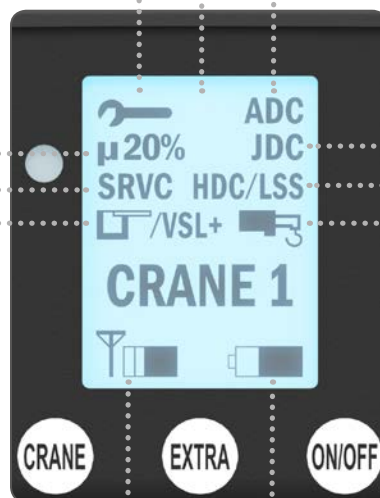

Centre display, view modes

Indication of micro / SRVC / MEWP / ADC / JDC / HDC / LSS / Manual extension

When one of the above functions is selected the symbol is enlarged (1) for 3 seconds before returning to its normal size (2) so as to alert the operator that a change has occurred.

Fault indication

An enlarged image of the fault symbol (3) appears and the crane stops when a critical fault is detected. To continue, the fault must first be confirmed by pressing the release button, only then will the spanner go back to normal size. (4)

When a non-critical fault is detected by the safety system an enlarged image of the spanner is shown (3) for 3 seconds before returning to normal size. (4)

Error code display

The safety system sends error codes to the hand controller. By pressing the info-button on the left hand side under the display handle (6) the centre display changes window to show the error codes. (5)

Error codes scroll up on the display at the same rate as the safety system sends them, once every half second.

If there are more than 6 error codes at the same time the 6 most recent are shown.

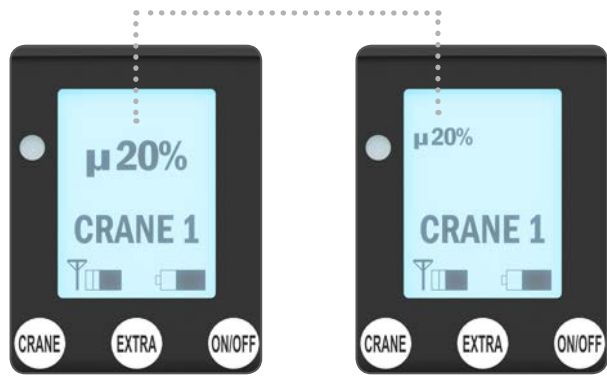

1

2

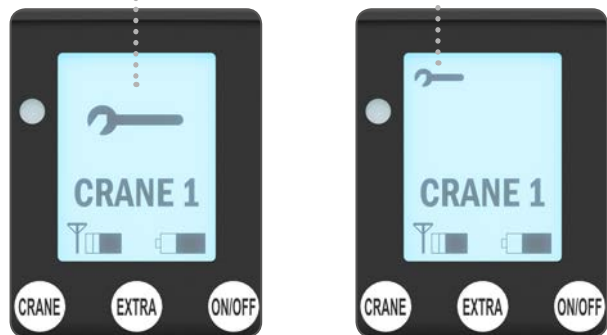

3

4

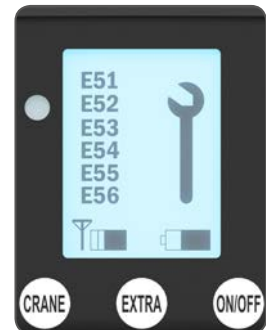

5

6



Info button for changing the centre display window.

Overload protection "OLP", warning signals

Olsbergs hand controllers can provide information about the pressure in cylinders equipped with pressure sensors. This information is linked directly to each function.

The pressure is shown as a percentage of the maximum pressure permitted, furthermore it also shows if a particular motion is prohibited or if the crane is subject to overload protection, (OLP).

There are three types of OLP:

Crane-OLP: means that the crane has reach maximum load.

Outrigger-OLP: means that one of the outriggers of the crane or vehicle has reach maximum load.

VSL-OLP: means that the stability limit of the crane or vehicle has been reached.

Overload is shown on the hand controller's displays as follows.

Crane-OLP

Indicated by showing 100% for those functions that have pressure sensors in the cylinders. Any movement that would increase the load is blocked. (1)

Outrigger-OLP

Outrigger-OLP means that one of the outriggers has reached maximum load and a symbol is shown in the centre display with the actual outrigger crossed.

At outrigger-OLP this symbol is shown irrespective of which menu is shown in the centre display. Outrigger-OLP "front left" or "front right" are indicated at the same spot on the symbol in the centre display.

VSL-OLP

VSL-OLP means that the stability limit of the crane/vehicle has been reached and VSL is indicated on the centre display.

If outrigger-OLP and VSL-OLP occur at the same time, VSL is indicated in the same symbol as the outrigger OLP.

At all types of OLP the crane/vehicle stops and all levers must be moved to neutral position before the crane/vehicle can be operated out of OLP position and the centre display returns to normal.



- 1 Inner boom at 100% load
- Outer boom up is blocked
- Extension out is blocked
- Jib up is blocked
- Extension jib is blocked



Regardless of which menu is active Outrigger – OLP will be shown. Here outrigger-OLP "mid left".

Outrigger-OLP "front left"/"front right"



VSL-OLP



VSL-OLP



Outrigger-OLP "mid left" occurred at the same time as VSL-OLP.

Overload protection "OLP", warning signals

Blocking on max load/release

When a function has been blocked due to an OLP, a cross is shown in the relevant lever's display when an attempt is made to activate it.

If the crane has got stuck the release button must be activated to enable it to be moved from its position. (2)

If the OLP release is accepted this is shown by an unlocked padlock in the centre display. (3)
The crane will then operate at reduced speed for a limited period of time.



"Release button"

2

Warning at 50%, 70%, 90% and 100%

Some of the crane's functions are connected to pressure sensors which show the pressure in these cylinders as a percentage of maximum permitted pressure when it exceeds 50%.

The percentage is shown as 50%, 70%, 90% or 100% alternating with the lever's symbol, once per second.

When a pressure sensor reaches 100% all motions that would increase the load can be blocked. These configurations are set by the crane manufacturer.

If the operator attempts to activate a blocked function a cross replaces the symbol. The cross disappears and the symbol returns when the lever is returned to the neutral position. (4)

Configuration

The hand controller must be configured specifically for the particular crane or vehicle if it is to show the correct symbol or text.

Default settings for the crane symbols are set in the factory during final testing. Configuration of other functions and tools is conducted by the coach builder when mounting the crane on the vehicle.

Cranes that have a safety system can utilise the terminal program to configure the crane. Non-CE cranes without a safety system can be configured via a computer or be adjusted in the factory.



3



4

Other instructions

Locking/unlocking the hand controller

The hand controller can be locked to prevent unauthorised persons, such as children, from starting the hand controller and operating the crane.

Locking the hand controller

1. Press the EXTRA button and the ON-OFF button when the stop button is pressed in.
2. Continue to hold the buttons pressed at the same time as the stop button is pulled out. The centre display will now show a locked padlock. **(1)**

Note!

If battery power drops too low the hand controller will lock automatically.

Unlocking the hand controller

1. Press the EXTRA button and the ON-OFF button when the stop button is pressed in.
2. Continue to hold the buttons pressed at the same time as the stop button is pulled out. The hand controller is ready for use. **(2)**

Low ambient temperature

The LCD-type displays on the hand controller are somewhat slow in changing state in low temperatures. At 0°C, it will take approximately 1 second, and at -20°C it can take up to 8 seconds before the symbols have been completely updated.

For safety reasons, quick shifts within a menu are not possible at temperatures below -10°C; though shifting between different menus will still be possible as normal.

To avoid the inconvenience that may be caused by the above, the hand controller should be stored at a temperature above +10°C when not in use.

No signal from the safety system

If a fault develops in communication with the safety system during operation, the system stops the crane. The centre display shows the spanner symbol to indicate that there is a fault. The crane can only be operated manually under emergency conditions if this occurs.



1



2

Replacing a hand controller or decoder

Every system has a unique controller/decoder pair which only communicates with each other. If one unit has to be replaced, a special procedure must be followed to make the new pair communicate. The procedure is as follows:

1. Switch off the Space X4 RC system.
2. Unscrew the protection cap on the decoder and remove it.
3. Connect the hand controller with the accompanying cable (E0781) to the decoder.
4. Switch on the Space X4 RC system and select "remote".
5. Hold down the release button on the hand controller while pulling out the stop button.

When the yellow LED on the decoder starts to blink, let go of the release button. When the procedure is complete, the yellow LED goes out. If the procedure was successful, only the green LED remains lit, if not, the red LED is lit. The procedure can take up to half a minute.

Other instructions

Cable control

The hand controller is normally used in radio mode but it is also possible to operate it via a cable.

A four-metre cable (E0781) is supplied as standard with the hand controller. The cable is intended to be used for short-term operation and when pairing in conjunction with the replacement of hand controllers or decoders. The cable connects to the vehicle via the decoder's CAN bus connector. **(3)**

If the hand controller is to be wired permanently or for a long period, an adapter cable (E0837) is run from the Space X4 RC system and installed at a suitable location on the vehicle. To give the operator greater freedom of movement, a 15-metre cable (E0782) is used between the adapter and the controller. **(4)**

When the cable is connected to the hand controller, the centre display shows that the controller is in cable operation mode. The symbols for signal strength (radio) and battery capacity are replaced with the symbol for cable operation. **(5)**

Engage manual extension

This function must be activated so that the safety system can calculate the capacity when manual extension is used. This is done by pressing the release and horn buttons at the same time until the manual extension symbol appears on the centre display. Use the same procedure to disengage the manual extension function.

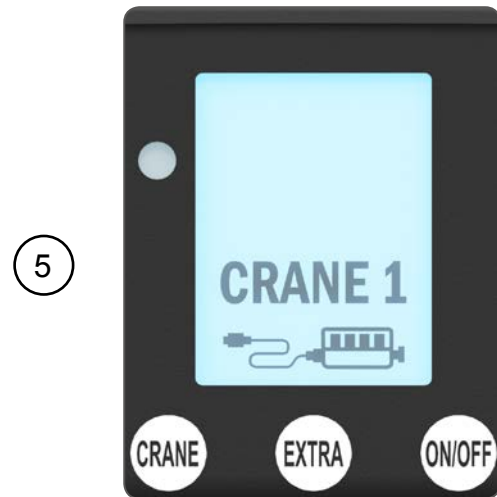

Controller display 6F MD3

Spare parts

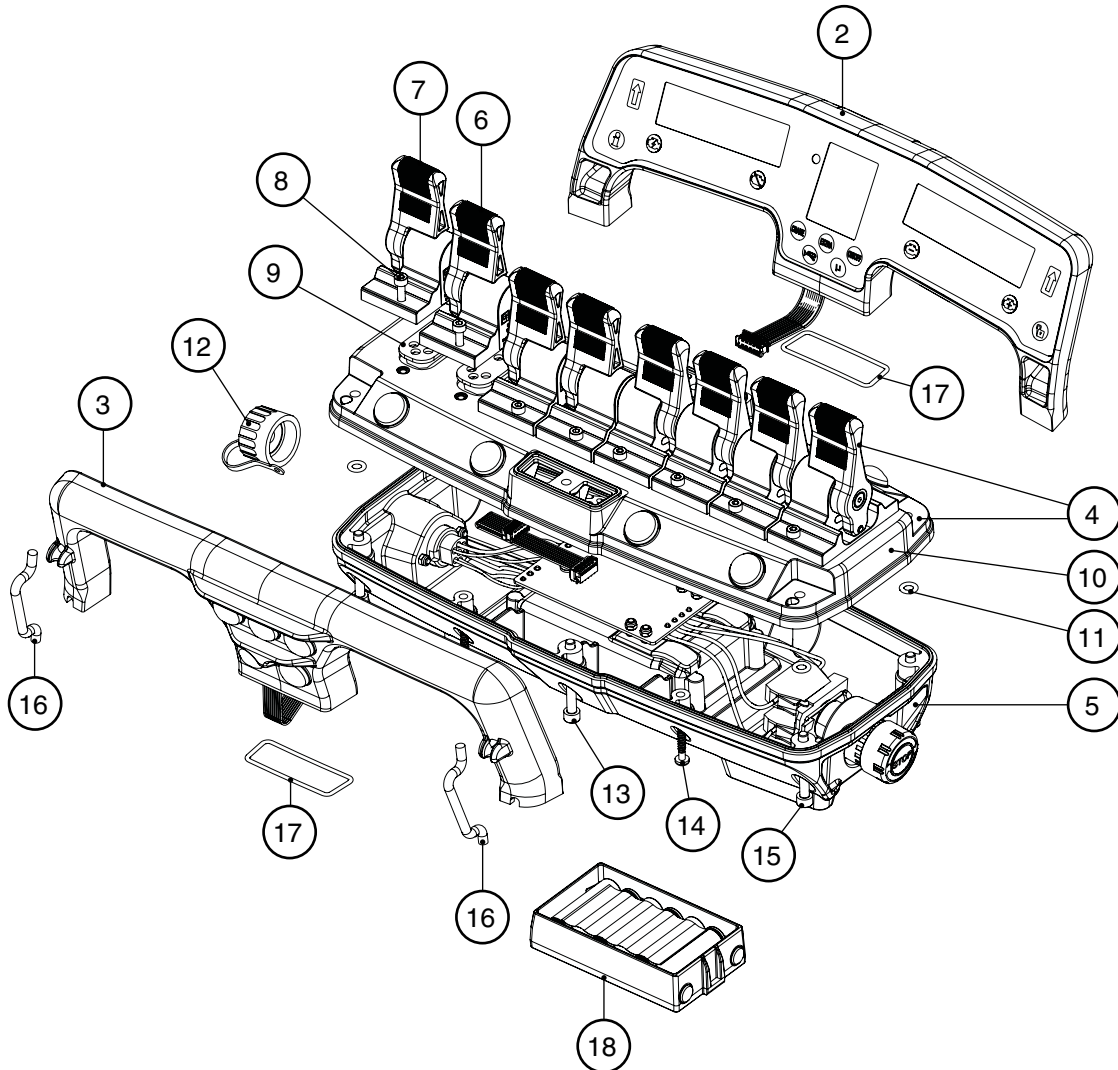

Pos.	Part no	Hiab no.	Description	Notes
1	1323	989 5001	Controller Display 8F MD3	Complete with all listed parts
2	E1763	989 5019	Handle, Display 8F MD3 G	Complete incl. symbol labels
3	E1761	989 5027	Handle, Push button 8F MD3	Complete
4	E1762	989 5035	Controller 8F, MD3 G, Top	Incl. levers
5	E1373	988 1557	Controller MD2 8F, Bottom	Incl. stop button, contact chassis and cap
6	0498	983 0022	Lever, Black	Incl. screw and packing
7	0499	983 0031	Lever, Red	Incl. screw and packing
8	S2831	981 1656	Screw M4x12 MC6S	A4 black nickel
9	E0447	983 0863	Packing lever	
10	E1776	989 5175	Top box, controller 8F MD3 G	Excl. levers
11	S2939	988 0038	O-ring Ø6,0x2,0	NBR 70 (4 pcs)
12	S2532	985 7338	Cap, controller	
13	S0238	983 0898	Screw M5x45 MC6S	A4 black nickel
14	S2938	987 5816	Screw T40x25 TX	
15	S2912	983 9101	Screw M5x40 MC6S	A4 black nickel
16	E1377	988 0992	Fittings, carrier strap	
17	S2940	988 0046	O-ring Ø45,0x2,0	NBR 70
18	1201	983 6721	Battery NiMH, 7.2 V	

Decoder / Radio MD3

Spare parts

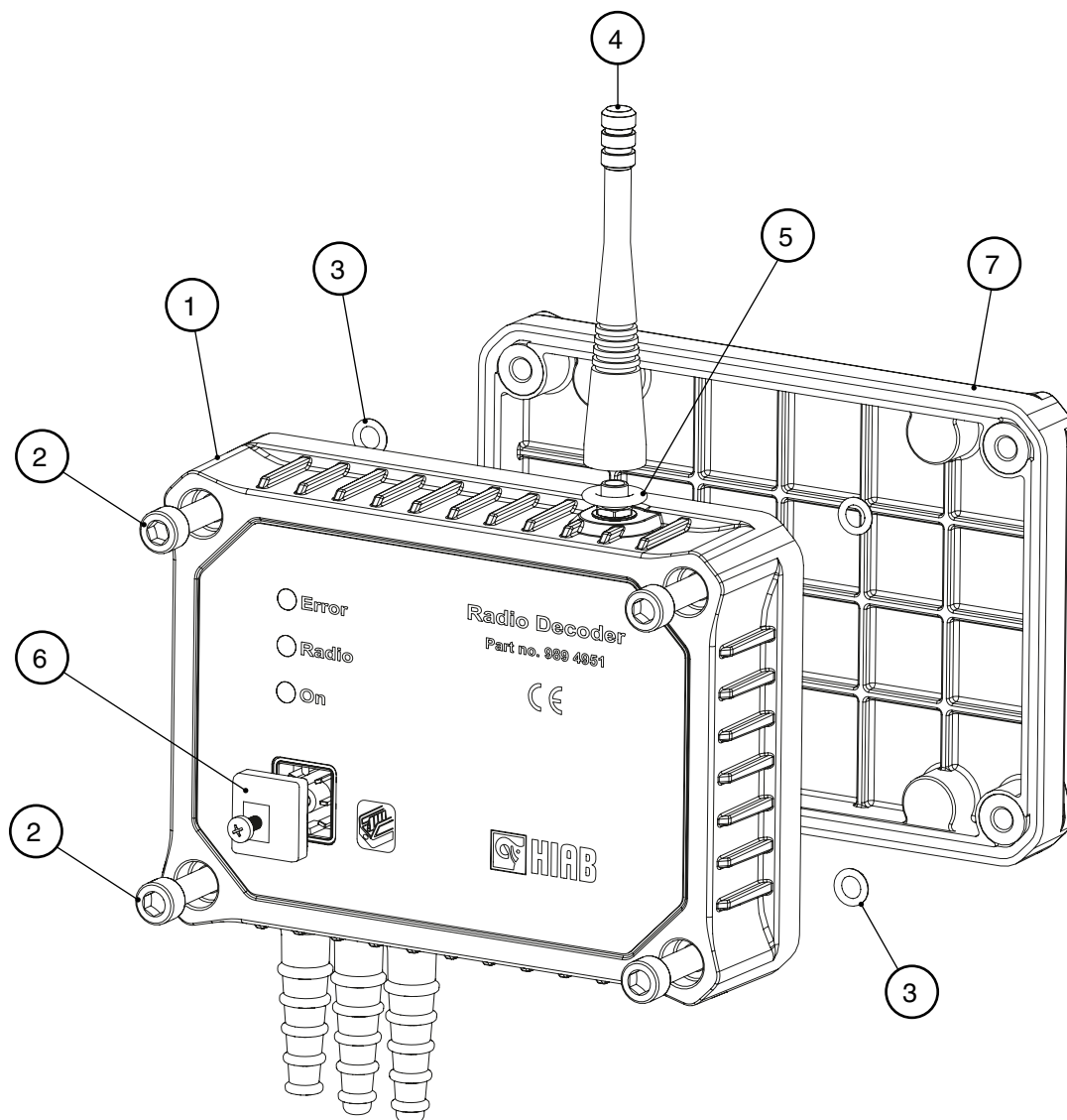

Pos.	Part no	Hiab no.	Description	Notes
1	1320	989 4951	Decoder / Radio MD3 G	Complete with all listed parts except E1432
2	S3152	988 3045	Screw M6x40 MC6S	A4
3	S2556	995 6328	O-ring Ø5,28x1,78	NBR 70
4	S3382	989 6066	Aerial, MD3	
5	S2948	988 6087	O-ring Ø8.0*3.0	EPDM
6	S2539	370 3223	Protective cap	
7	E1432	989 4250	Bottom box, low	Incl. o-ring



MultiDrive 3

Controller Display 8F

Olsbergs Hydraulics AB

Box 17
SE-575 21 Eksjö
Sweden

Phone: +46 (0)381 15075
E-mail: hydraulics@olsbergs.se

Olsbergs Electronics AB

Box 267
SE-186 24 Vallentuna
Sweden

Phone: +46 (0)8 511 858 50
E-mail: electronics@olsbergs.se

EU Declaration of Conformity

We, **Olsbergs Electronics AB**
Of, **Fågelsångsvägen 10, SE 186 42 Vallentuna, Sweden**

declare under our sole responsibility that the product(s):

Product Name: MultiDrive 3
Model (s): Controller 6F, Controller 8F, Decoder
Part Number(s): 1319, 1323, 1320

to which this declaration relates is(are) in conformity with the essential requirements and other relevant requirements of EU Directive 2014/53/EU (RED) Radio Equipment Directive.

<u>Type</u>	<u>Essential Requirements</u>
Health & Safety (article 3.1a)	EN 62368-1:2014 EN 62311:2008
EMC (article 3.1b)	EN 301 489-1 V2.1.1 (2017-02) in accordance with the specific requirements of EN 301 489-3 V2.1.1 (2017-03)
Spectrum (article 3.2)	EN 300 220-2 V3.1.1 (2017-02)

Vallentuna, Sweden, August 2017

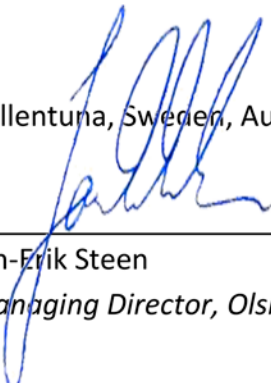

Jan-Erik Steen
Managing Director, Olsbergs Electronics AB